

F

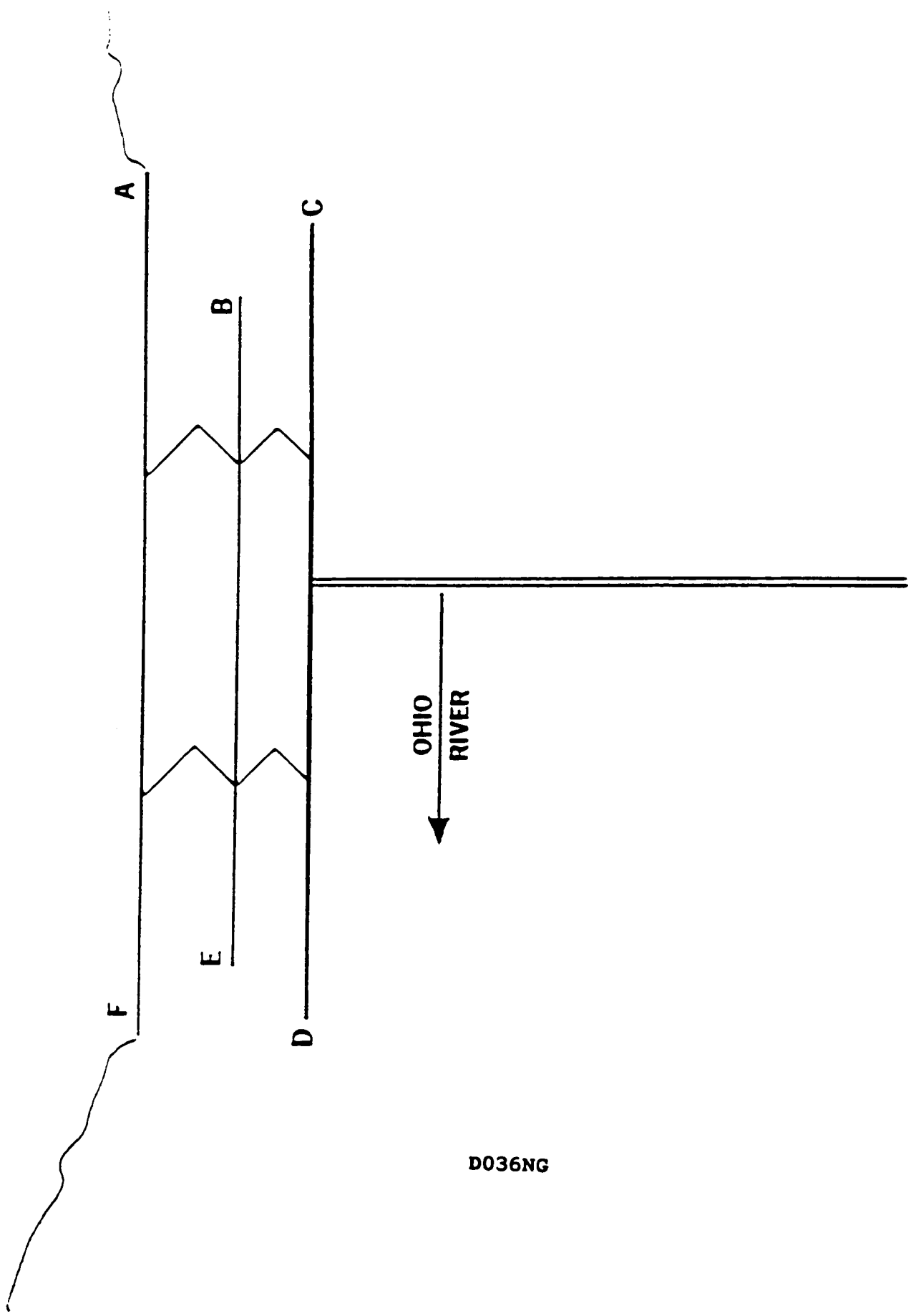

D036NG

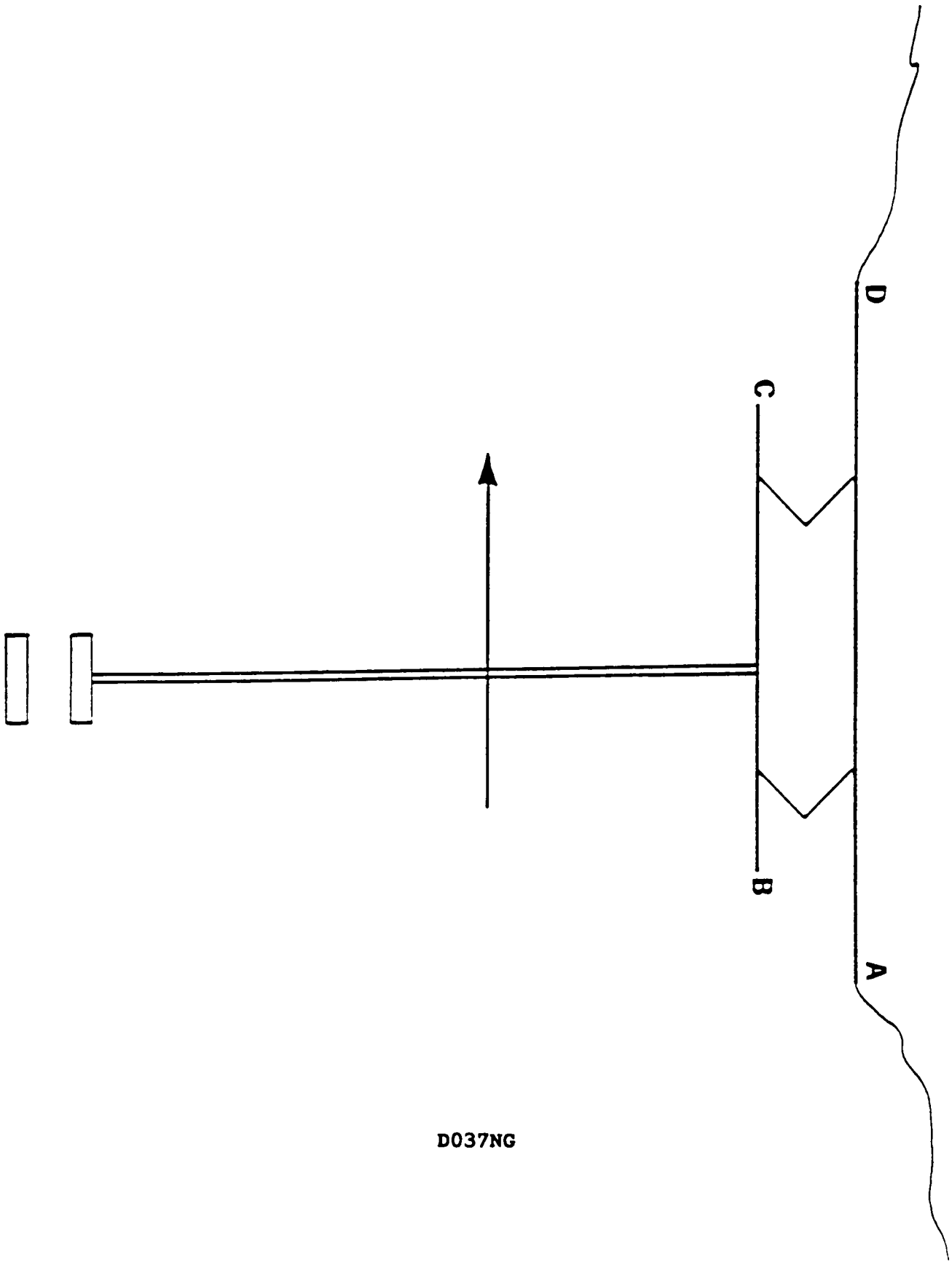

D037NG

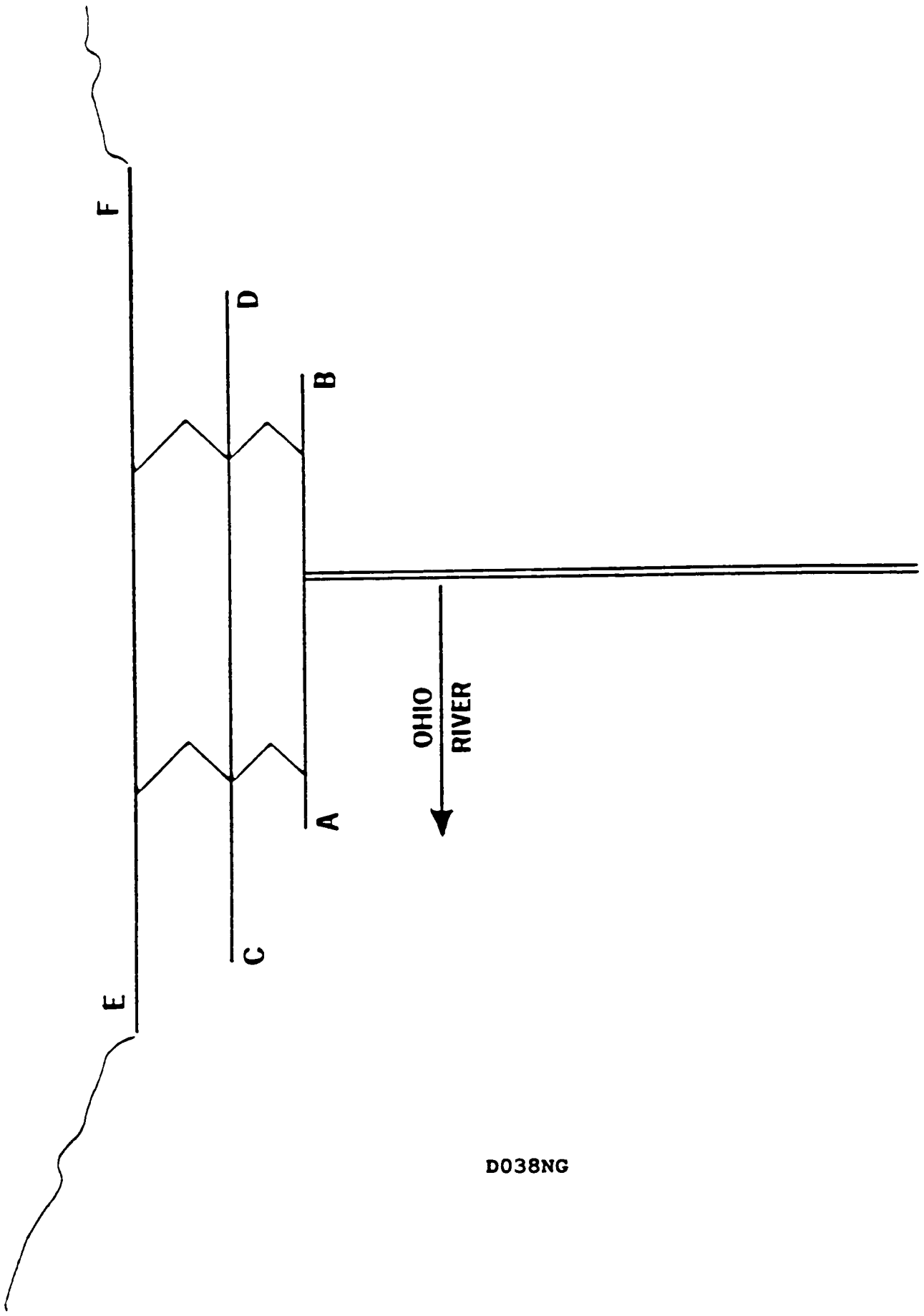

D038NG

ALTITUDE IN FEET

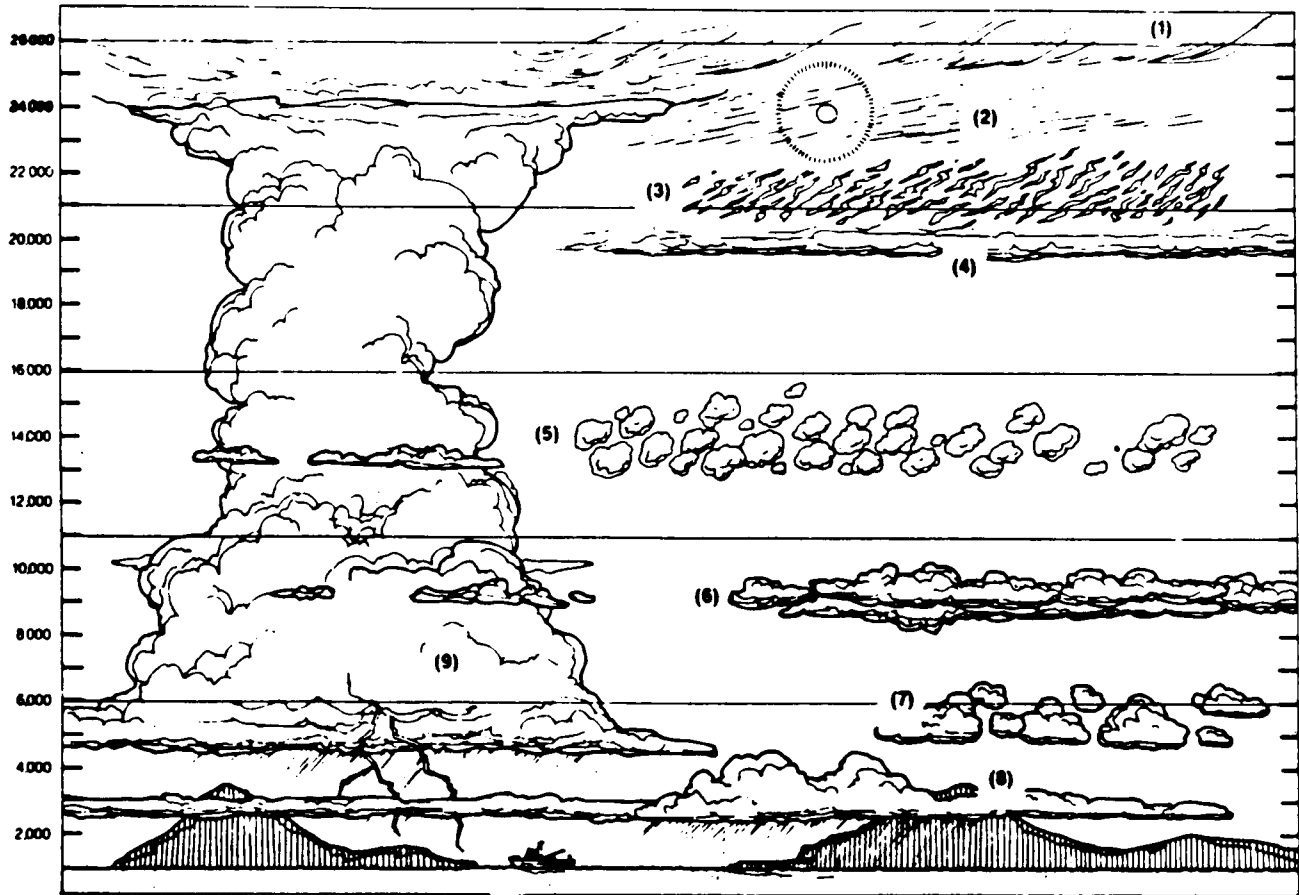

Illustration courtesy NPFVAO SAFETY MANUAL. Produced in cooperation with the National Fisheries Service and U.S. Coast Guard.

D039NG

HEADING (GYRO)	VISUAL BEARING (GYRO)	RDF BEARING (GYRO)
061°	061°	062.5°
089°	059°	061.5°
114°	054°	057°
129°	039°	041°
144°	024°	025°
167.5°	017.5°	017°
197°	017°	016°
233.5°	023.5°	021.5°
271°	031°	027°
309°	039°	037.5°
336.5°	046.5°	046°
023.5°	053.5°	054°

D040NG



WEATHER REPORT FOR IMMEDIATE TRANSMISSION

NO.	SHIP NAME	DATE SENT (GMT)	TIME SENT (GMT)	STA. CALLED	FREQUENCY

ADDRESSES

U.S. Coast Guard: No address needed, start with ship's call sign.

INMARSAT: Select—Coast Earth Station (CES), routine priority, duplex telex channel, and initiate call. When GA + is received, select 41 + . Upon receipt of answerback, NWS OBS MIITS, send the weather report starting with the ship's call sign. End the report with 5 periods.

U.S. commercial and foreign radio stations: To: OBS METEO _____
 (Get address from "Radio Stations Accepting....."). Start with ship's call sign and combine the remaining numbers into 10-character groups.

STORM or SPREP	CALL SIGN	YGGI _w	99L _a L _a L _a	O _c L _o L _o L _o	I _n I _n I _n	Nu _d I _f
1 _g T _T	2 _n T _d T _d	4PPPP	99	7wwW _w	4	2220 _y s
0 _n I _w I _w	2P _w P _w I _w I _w	3d _w d _w d _w d _w	4P _w I _w I _w I _w	5P _w 2 _w 2 _w 2 _w	6I _s E _s E _s	ICE

PLAIN LANGUAGE

TRANSMITTED BY

No Government Administration, or Company or person employed in the forwarding and delivery of this message shall be liable for any loss or damage arising from failure to transmit or to deliver the said message or from any neglect, delay, error or omission in the transmission thereof.

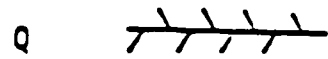

D042NG

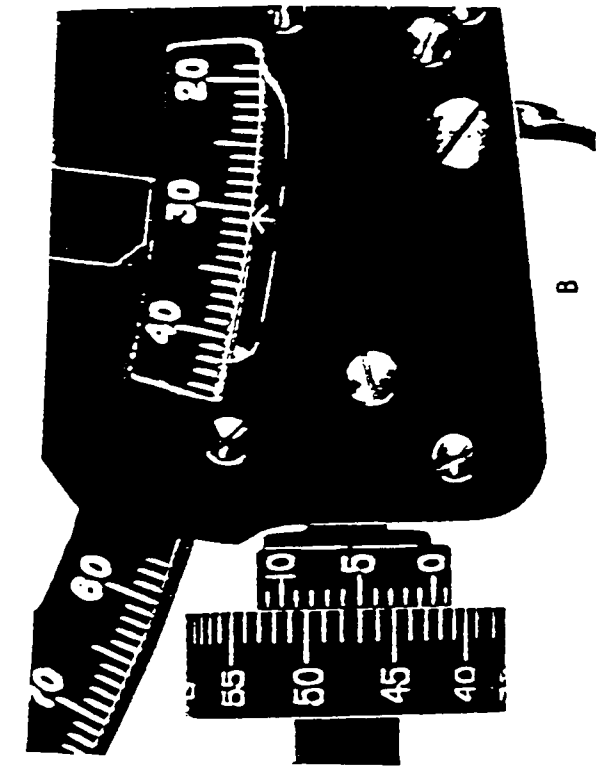

B

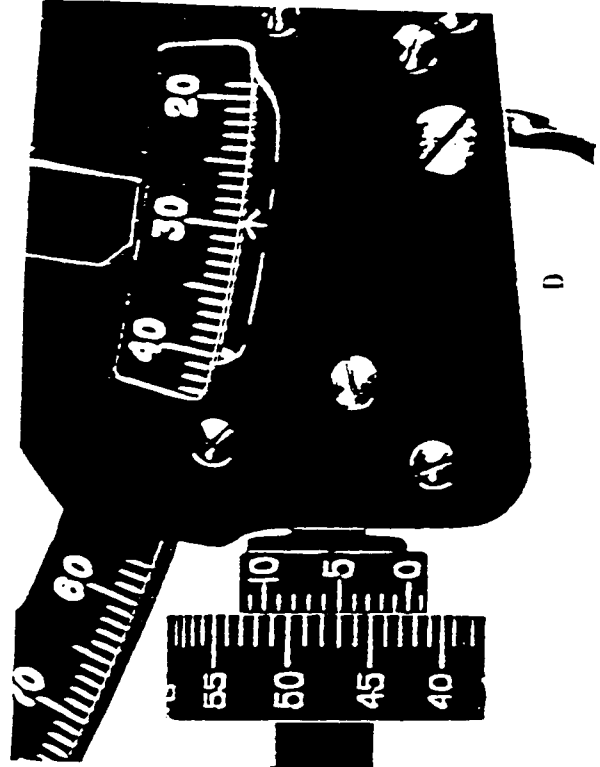

D

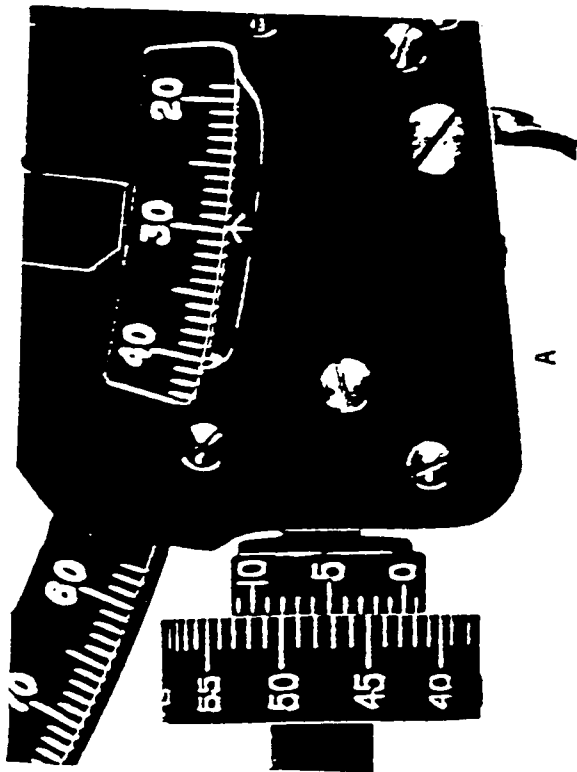

A

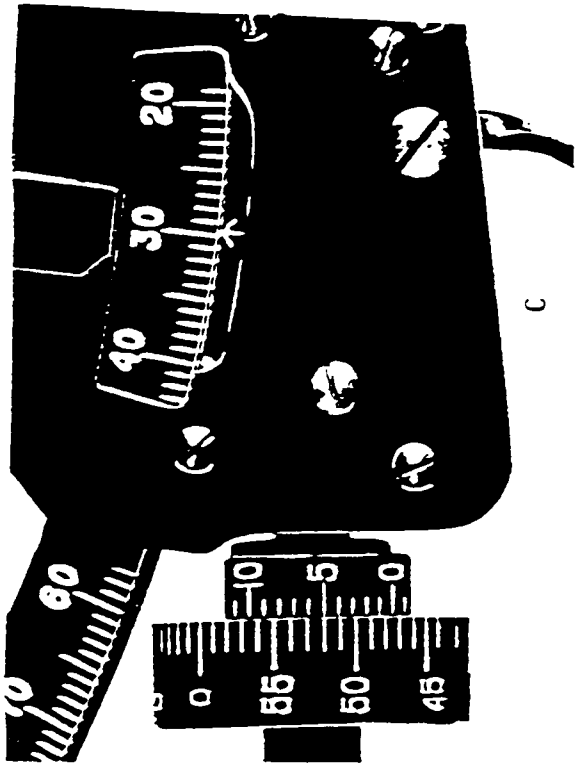

C

D043NG

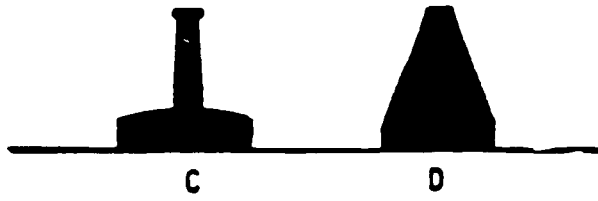
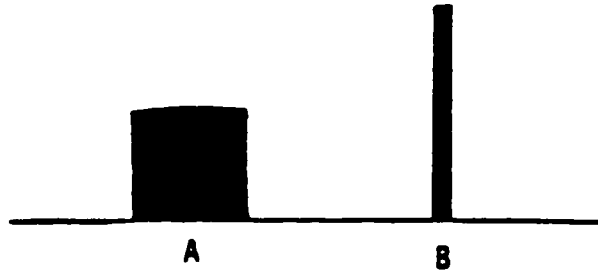

D044NG

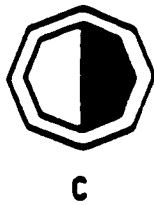
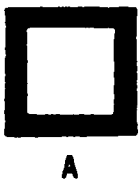

D045NG



D046NG

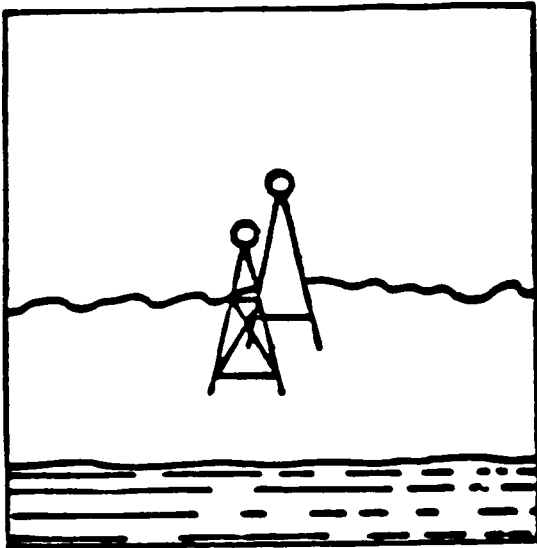

D047NG

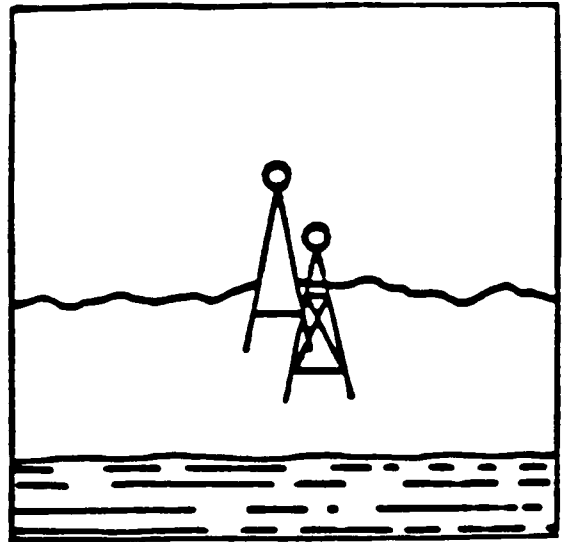

D048NG

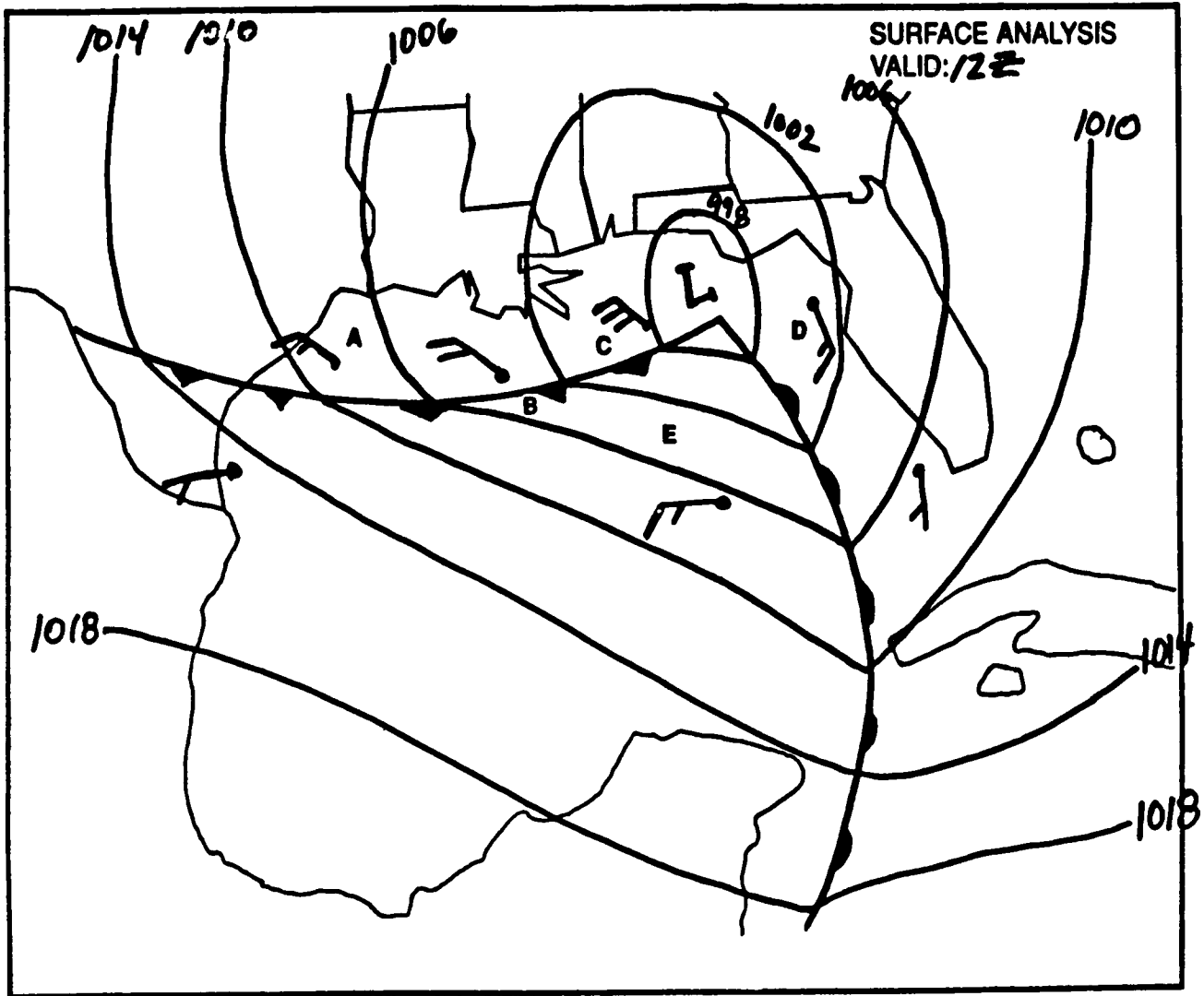

D049NG

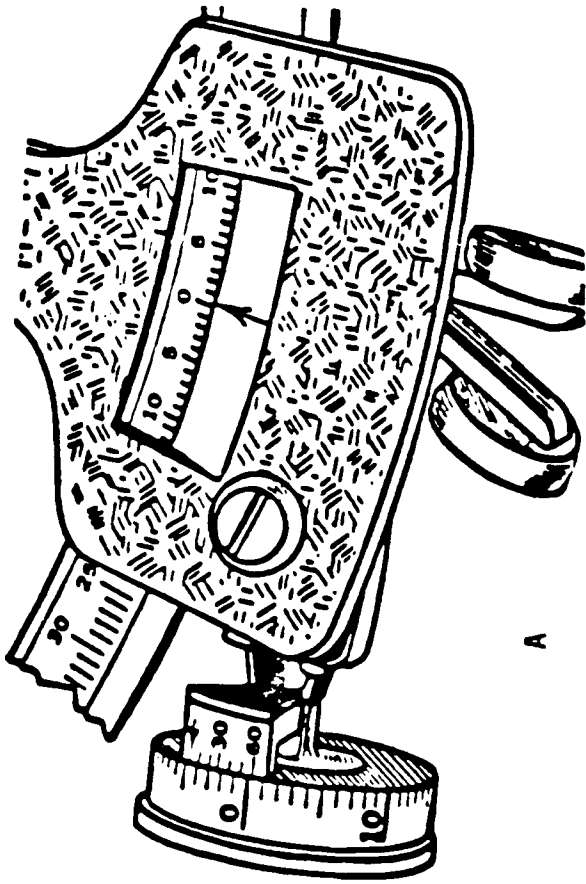

A

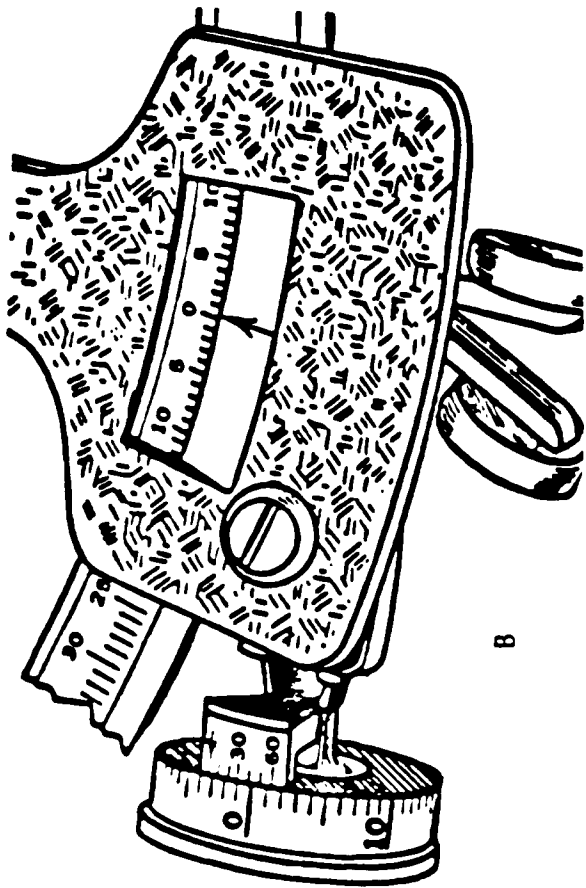

B

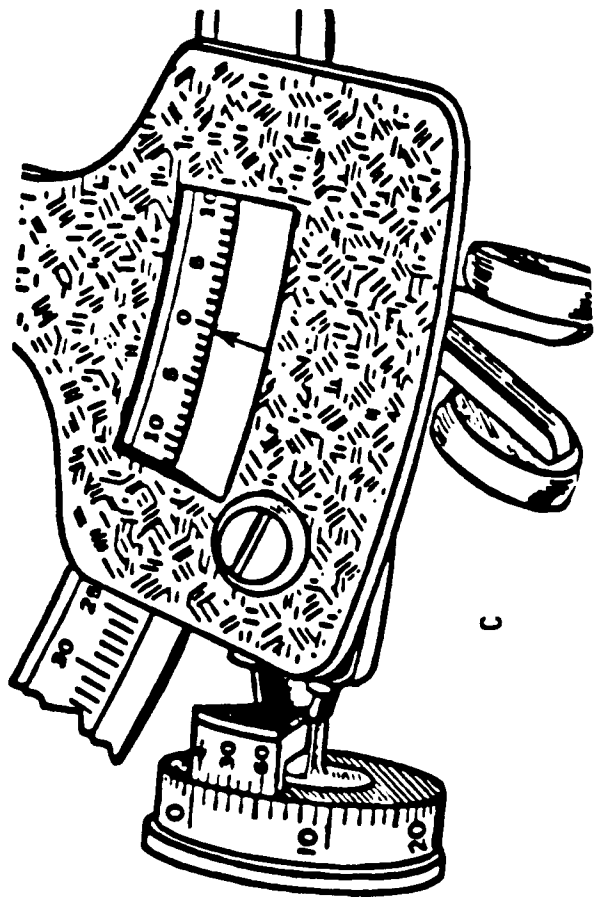

C

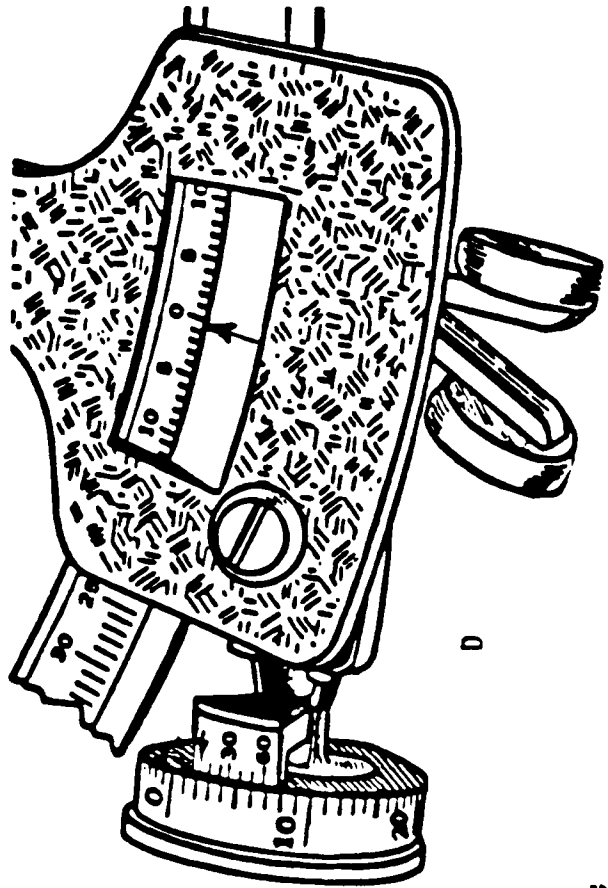

D

D050NG

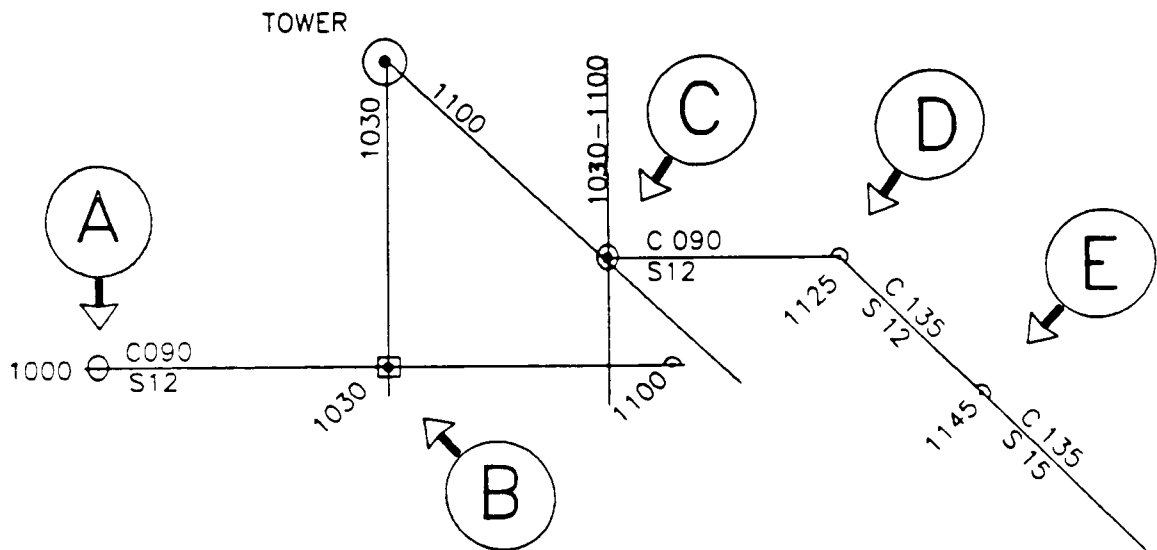

D051NG